

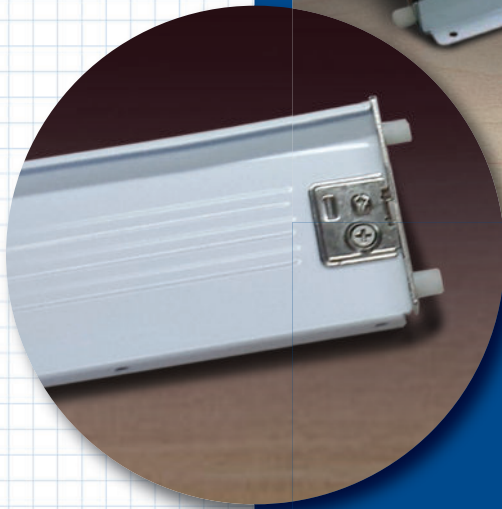

# Metal Drawer System

An excellent quality  
production drawer  
competitively priced.

100 lb. Carrying Capacity



The CGS Drawer System offers the following...

**Features:**

- ▶ Self Closing
- ▶ Double Captive
- ▶ 32 mm Compatibility
- ▶ Easy Front Mounting
- ▶ Load Capacity: 100 lbs
- ▶ Material: Cold Rolled Steel
- ▶ Durable Epoxy Powder Coating
- ▶ Four Way Adjustable Drawer Fronts

**Applications:**

- ▶ Store Fixtures
- ▶ Office Furniture
- ▶ Kitchen Cabinets
- ▶ Medical Equipment
- ▶ Architectural Millwork
- ▶ Manufactured Housing

**Available in:**

- ▶ Heights: 86mm and 150mm
- ▶ Lengths: 350mm, 400mm, 450mm and 500mm

To order please contact  
your local distributor.



COMTRADSOURCING.com  
1-866-200-0564

# Metal Drawer System

## Drawer Assembly Specification

1. Use wood screw to fix the drawer bottom and slides.

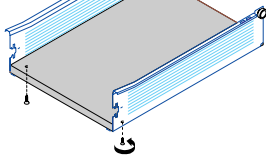

2. Place drawer back between drawer slides.

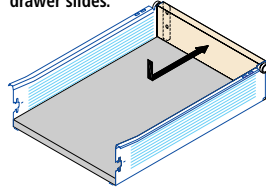

3. Use wood screw to fix the drawer back and drawer slides.

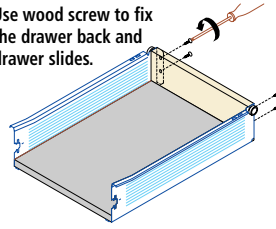

4. Attach fixing brackets onto drawer front with predrilled 10mm holes (30mm pitch).

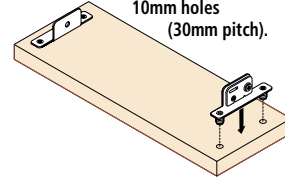

5. Install drawer front by inserting fixing brackets into drawer slides.

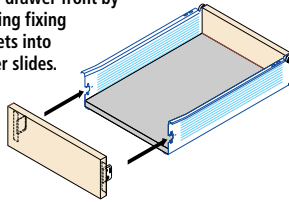

6. Tighten screws on the fixing brackets to fix the drawer front and drawer slides.

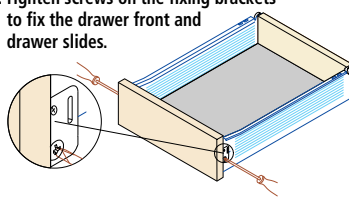

7. If the drawer front is not in the correct position, use adjustment screws to adjust. "A" is to adjust left and right, "B" is to adjust up-and-down.

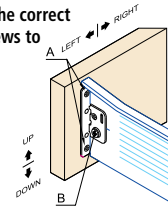

Drawer Height	D	E	F
86	80	8	64
150	144	72	64

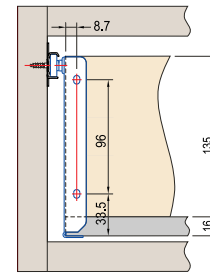
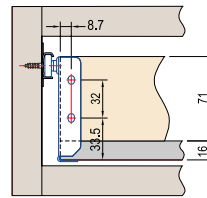
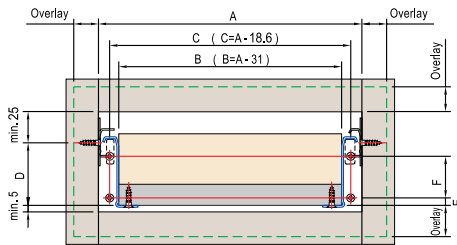

## Hole Patterns

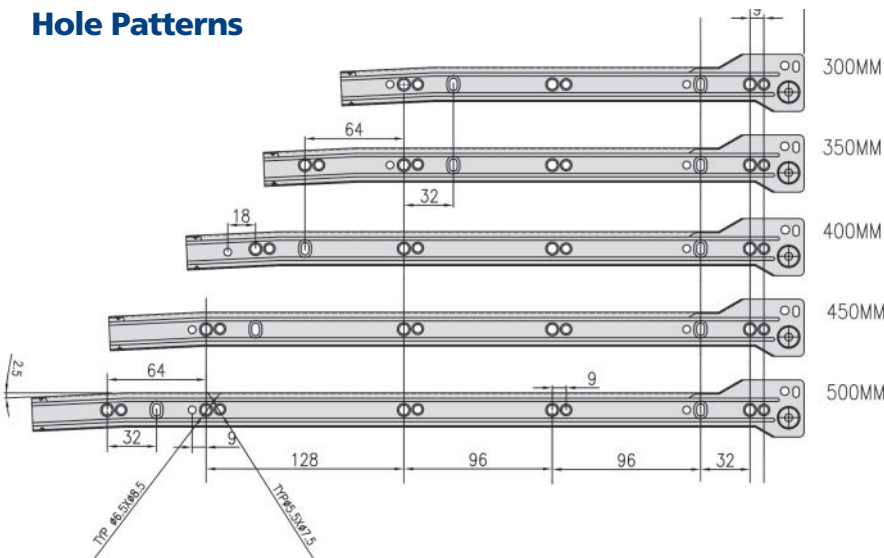

## Ordering Information

Item	Description	Carton Quantity
281-001	86mm High x 350mm Long White	10
281-002	86mm High x 400mm Long White	10
281-003	86mm High x 450mm Long White	10
281-004	86mm High x 500mm Long White	10
281-005	150mm High x 350mm Long White	10
281-006	150mm High x 400mm Long White	10
281-007	150mm High x 450mm Long White	10
281-008	150mm High x 500mm Long White	10

